



LIGHTING CONTROLLER



DONGGUAN YOUEASY ELECTRONIC TECHNOLOGY CO., LTD

8/F, Changrong High-tech Park, Huaide Yayao Industrial Zone, Humen Town,
Dongguan City, Guangdong Province, China

Website: www.szyoueasy.com Wechat/Whatsapp: +86 189-3816-0702 Email: sales@szyoueasy.com

LIGHT IS ART

LIGHTING LIKE GREAT ART IS NOT SIMPLE
BUT WE MAKE IT AS EASY AS FLIPPING A SWITCH

天空之城
SKY

IN SKY

天空之城

INTEGRATED SOLUTION FOR INTELLIGENT VISION SYSTEM

ABOUT YOU EASY

Dongguan Youeasy Electronic Technology Co., Ltd, founded in 2013, is a pioneering manufacturer of professional entertainment lighting, architectural lighting, lighting controller. Supported by extensive R&D, productions and sales, we provide one stop solutions and integrated designs to beautify the stage and environment projects of any scale.

Uniting over 250 employees in Dongguan, Foshan, Chengdu, Shenzhen, Jinan, Hangzhou of China, YOUEASY has become a leading brand in the entertainment lighting industry and successfully proliferated its products and solutions throughout the vast expanse of China. From major entertainment venues to the small corners of streets, Youeasy has left its mark, contributing its expertise to enhance the entertainment experience in diverse locales. We take pride in playing a significant role in contributing to the enjoyment of the general public.

Starting from the summer of 2023, YOUEASY embarked on a journey into the international market, aspiring to showcase our products worldwide by leveraging our professional research and development, as well as unique designs. This expansion marks a significant milestone as we aim to bring our cutting-edge technology and integrated solutions to customers across the globe.



YOUEASY's core mission is to create the visual atmosphere for commercial projects and regard this as our long-term strategic goal. Lighting like great art is not simple, but we make it as easy as flipping a switch! Looking forward to see YOUEASY products in all small and large venues worldwide, different applications like bars, discos, mobile DJs, karaoke, nightclubs, television studios, theaters, churches, restaurants, hotels, schools, cruise ship, theme park etc. With a commitment to excellence, YOUEASY is dedicated to making a global impact and establishing a presence in the international markets.



CORE MISSION

DEVELOPMENT STORY

- In 2013 >** YOUEASY established in Shenzhen, China with a complete set of intelligent lighting controllers.
- In 2014 >** YOUEASY launched 802D lighting controller, supporting DMX512 control protocol.
- In 2015 >** YOUEASY's first lighting controller that supports sound and light linkage was born - 802X.
- In 2016 >** YOUEASY's intelligent lighting control solutions are widely promoted and extensively applied.
- In 2017 >** YOUEASY started the independent research and development of entertainment lighting fixtures, giving birth to the classic E series.
- In 2018 >** YOUEASY's first 9000 series controller with lighting control software is born, along with the launch of several independently developed lighting fixtures.
- In 2019 >** YOUEASY's lighting solutions integrate architectural lighting products, fully entering an era of overall lighting solutions.
- In 2020 >** YOUEASY obtained ISO9000 quality certification, implementing comprehensive quality management.
- In 2021 >** Youeasy's entertainment lighting is rapidly popularizing even during Covid, positioning YOUEASY once again at the forefront of the industry.
- In 2022 >** Transitioned from upgrading lighting solutions to overall visual solutions, YOUEASY enters a new stage of development.
- In 2023 >** The revolutionary ID series show system controllers is born, marking YOUEASY's expansion beyond the entertainment industry into a wide range of commercial scenarios.

QUALITY ASSURANCE

Your Trustworthy Partner

YOUEASY owes two manufacturing plants in Dongguan, Foshan, R&D center in Chengdu, and multi sales & service branches in Shenzhen, Jinan, Hangzhou, Zhengzhou etc. YOUEASY has successfully achieved the internationally-recognized ISO9001 standard, and CE, RoHS certificates. With strong technical support, we provide customers with high-quality professional pre-sale, sale and after-sale service, constantly striving towards our ultimate goal of zero defects.



APPLICATIONS

NIGHTLIFE & CLUBS



MOBILE BAND & DJS



CORPORATE & PRIVATE EVENTS



BARS & RESTAURANTS



HOTELS & RESORTS



CONVENTION CENTERS & TRADE SHOW



PROJECT CASE

JC Party

JC Party is situated in the central area of Tianfu New City in Chengdu, covering an expansive 8,000 square meters with 44 party rooms. With a substantial investment of tens of millions and cutting-edge lighting and mechanical equipment valued in the millions, JC Party aims to provide a comprehensive and immersive entertainment experience. The project focuses on creating a space that enhances the quality of entertainment life.



INXX PARTY

Located in Changsha, INXX PARTY nightclub is a multifaceted entertainment complex that integrates "performance, listening, playing, and exhibition," creating a versatile and comprehensive space for entertainment. With a total investment exceeding 35 million US dollars, it stands as a world-class nightclub. This project represents a significant investment to establish one of the premier nightlife destinations globally, showcasing a commitment to offering diverse forms of entertainment under one roof. The INXX PARTY aims to set new standards in the nightlife industry, providing an unparalleled experience for patrons with a substantial investment in facilities, technology, and overall ambiance.

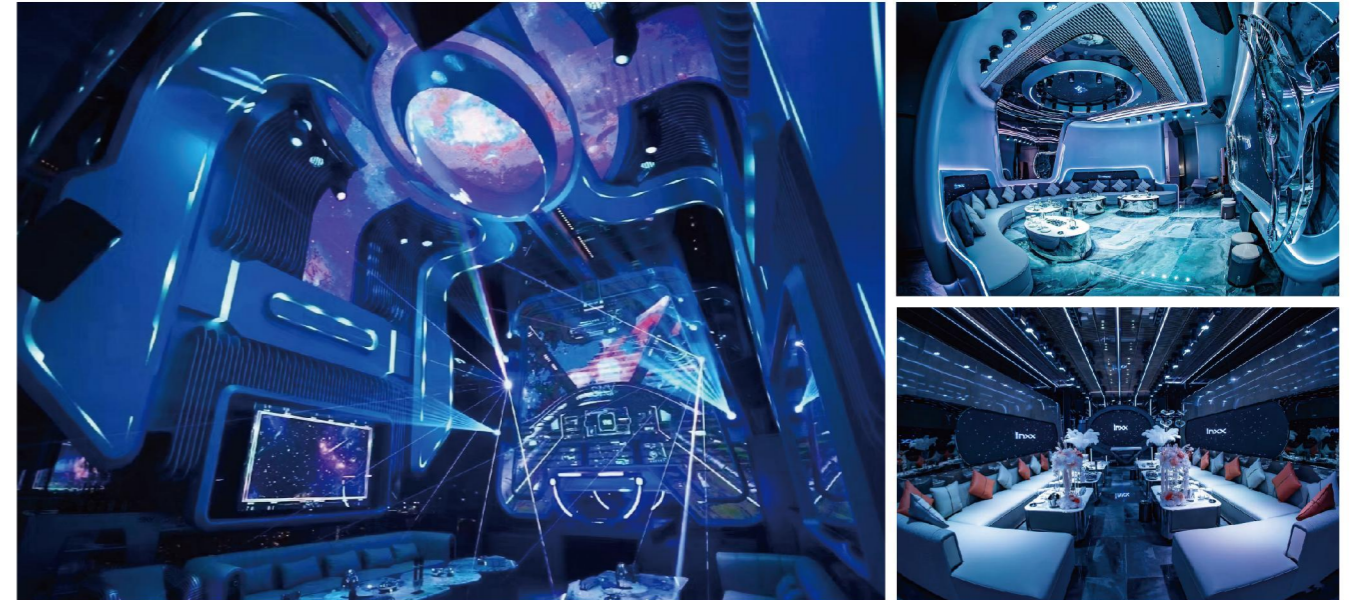

1001

"Nanjing 1001" is a locally originated brand by 1001PARTY in Nanjing. It innovatively merges KTV entertainment with a CLUB experience, constantly introducing unique and distinctive playing styles. The project aims to create nine distinct PARTY ROOMS, each offering a different style of experience, providing a diverse range of options for patrons. The themed rooms range from vibrant and energetic to more intimate and tailored experiences, offering a variety of atmospheres to suit different preferences.



WEGO PARTY-K

WEGO PARTY-K is an all-encompassing immersive space that seamlessly integrates vocals, lighting effects, and electronic music. Spanning over 3000 square meters, it is a colossal "cyberpunk music battleship" designed to perfection. Featuring 51 uniquely themed private rooms, WEGO PARTY-K has become the trendy go-to destination for the youth in Chengdu. The project is a convergence of voice, lighting, and electronic music within an intelligent and technologically advanced environment.

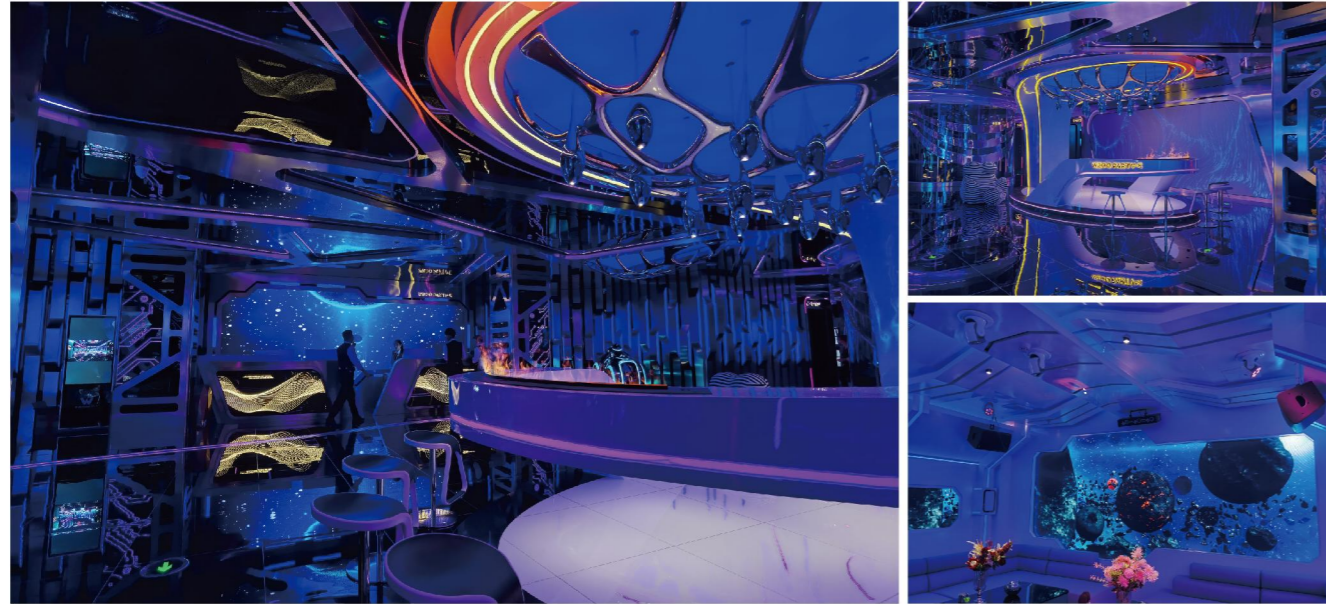

Windsor W+KBar

Windsor W+KBar is the trendy hotspot located in Changsha's Jiefang West area, seamlessly combining KTV and Bar elements to create an immersive social gathering space. Skillfully merging a variety of trendy elements, the venue is designed to be a hub for immersive social interactions.



SKY CITY

Sky City is the largest entertainment complex in Shenzhen, with an investment of 58 million US dollars. This cutting-edge venue represents a bold upgrade to the KTV entertainment experience, featuring an environmentally friendly and trendy space, establishing itself as an immersive urban social center.

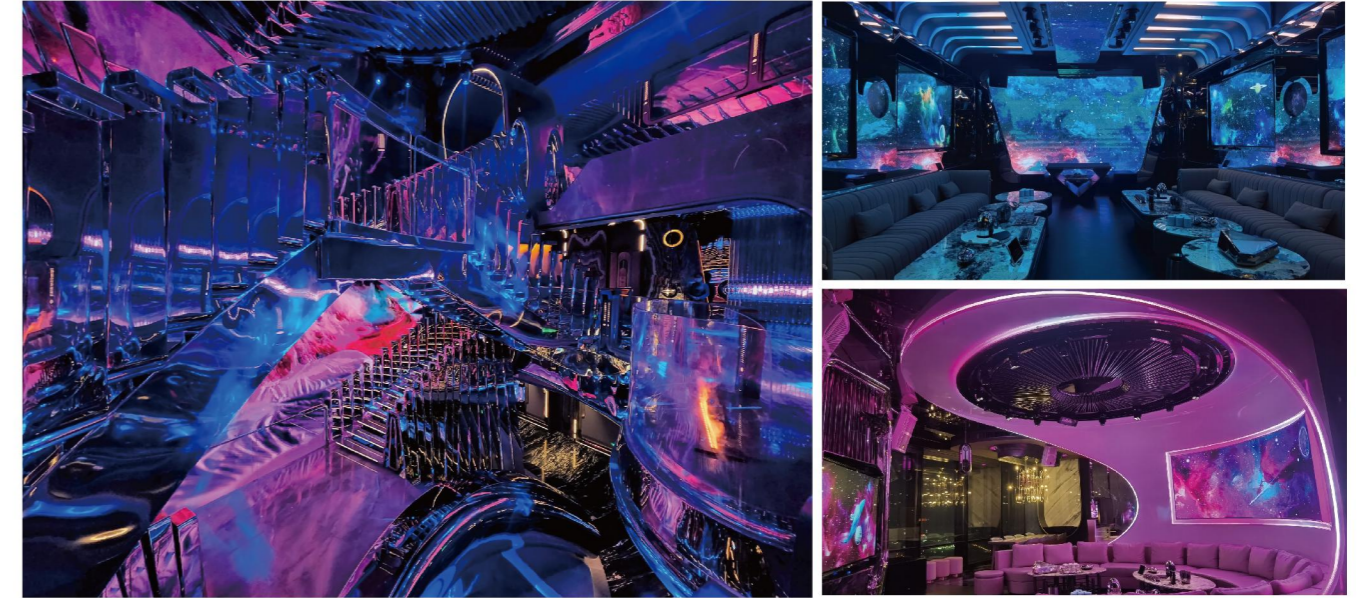

LONGMENGZHEN PUB

LONGMENGZHEN PUB is the first restaurant and bar in China with the core product line centered around the cultural and artistic elements of the Shu Han period in the Three Kingdoms era. Operating across multiple time slots, it offers a distributed range of products including afternoon tea, meals, and beverages. The establishment aims to create a distinctive Chinese pop-culture entertainment landmark by providing an immersive experience that transcends time and dimensions, seamlessly blending the ancient and modern.



YOUFEASY

LIGHTING CONTROLLER

With bold innovation, independent research, development and industry-leading technology, YOUFEASY developed the first embedded hardware with YOS lighting operating system, representing a true built-in console.

In the field of intelligent lighting, the product line is extremely diverse, covering three major categories: intelligent lighting controller, entertainment lighting fixtures, and architectural lighting with hundreds of models.



01

SHOW SYSTEM CONTROLLER

DMX CONTROLLER

ID-750

SHOW SYSTEM CONTROLLER

(7-IN-1 FUNCTION)



FEATURES

With the control system as the core, YOUEASY show system controller deeply integrates and controls multiple subsystem devices such as lighting, video, and audio. YOUEASY system achieves interconnection and communication between devices and subsystems, reducing the dependence on professional personnel and supporting unmanned operation.

ID-750 builds in an embedded system, supported by powerful hardware performance. With strong output and centralized control capabilities, ID-750 show system controller can control all devices seamlessly.

Unlike the "scene-level" linkage between subsystems in traditional solutions, ID-750 can easily achieve "frame-level" linkage, allowing precise control of visual effects output, especially for lighting shows that require high precision control. ID-750 show system controller represents a revolutionary breakthrough and helps the programmers accurately grasp visual effects, achieving the real "what you see is what you get". Programming for various subsystems, whether it's stage lighting, ambient lighting, or video VJ control, is no longer done separately; instead, it is completed within the same software, significantly reducing debugging workload.

- Internet Of Things
- 7-in-1 Function
- Unattended
- Lighting Show
- APP Support

TECHNICAL PARAMETERS

- 1. Video Control:** Dual channels with video capture and segmentation function, 4K HD output.
- 2. DMX Lighting Control:** DMX512-2048CH output, Artnet - 8192CH output.
- 3. LED Strip Light Controller:** Supports 200,000 pixels.
- 4. Audio Switching:** Support 2 groups of audio inputs and switching.
- 5. Centralized Control:** Connects to wall panels and door plates by the LINK protocol, communicates with VOD, and infrared controls power amplifier and air conditioner.
- 6. Audio Player:** Can upload audio in formats such as MP3, enabling audio playback synchronized with lighting, perfectly matching for lighting shows.
- 7. MQTT Server:** Facilitates interaction with tablet apps, supporting app control.

APPLICATIONS



PRODUCT DIMENSIONS

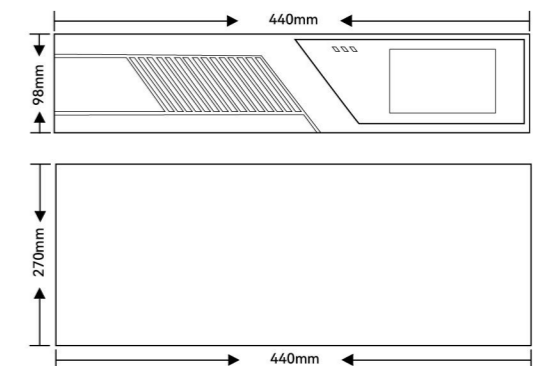

SERIES ID

SHOW SYSTEM CONTROLLER



Technical Parameters	ID-750A	ID-750B	ID-700
Hardware system	Android 11.0, stable and efficient.		
Power consumption	AC 110-240V, 50HZ	AC 110-240V, 50HZ	AC 110-240V, 50HZ
Video Control	Dual channels with video capture and segmentation function, 4K HD output.	Dual channels with video capture and segmentation function, 2 Channels of 2K HD output.	Dual channels with video capture and segmentation function, 4K HD output.
DMX Lighting Control	DMX512-2048CH output, Artnet - 8192CH output.		DMX512-2048CH output, Artnet output.
LED Strip Light Controller	Supports 200,000 pixels.		None
Audio Swithing	Support 2 groups of audio inputs and switching.		
Centralized Control	Connects to wall panels and door plates by the LINK protocol, communicates with VOD, and infrared controls power amplifier and air conditioner.		
Audio Player	Can upload audio in formats such as MP3, enabling audio playback synchronized with lighting, perfectly matching for lighting shows.		
MQTT Server	Facilitates interaction with tablet apps, supporting app control.		
Installation Methods	Supports rack-mounted.	Supports rack-mounted.	Supports rack-mounted.
Dimension	440*270*90	440*270*90	440*270*90

SERIES ID

SHOW SYSTEM CONTROLLER



Technical Parameters	ID-800	ID-900
Hardware system	Android 11.0, stable and efficient.	Android 11.0, stable and efficient.
Power consumption	AC 110-240V, 50HZ	AC 110-240V, 50HZ
Video control	Supports	Supports
Stage lighting control	2048CH DMX512 output/ 8192CH ART-NET output	2048CH DMX512 output/ 8192CH ART-NET output
LED Strip Light Controller	Supports 200,000 pixels.	Supports 200,000 pixels.
Digital Sound Mixer	Supports	Supports
Conference control function	Supports	None
Centralized Control	None	Supports
Built-in digital power amplifier system	None	Supports (external POE power supply)
Installation Methods	Supports rack-mounted.	Supports rack-mounted.
Dimension	440*270*90	440*270*90

TOPOLOGY DIAGRAM

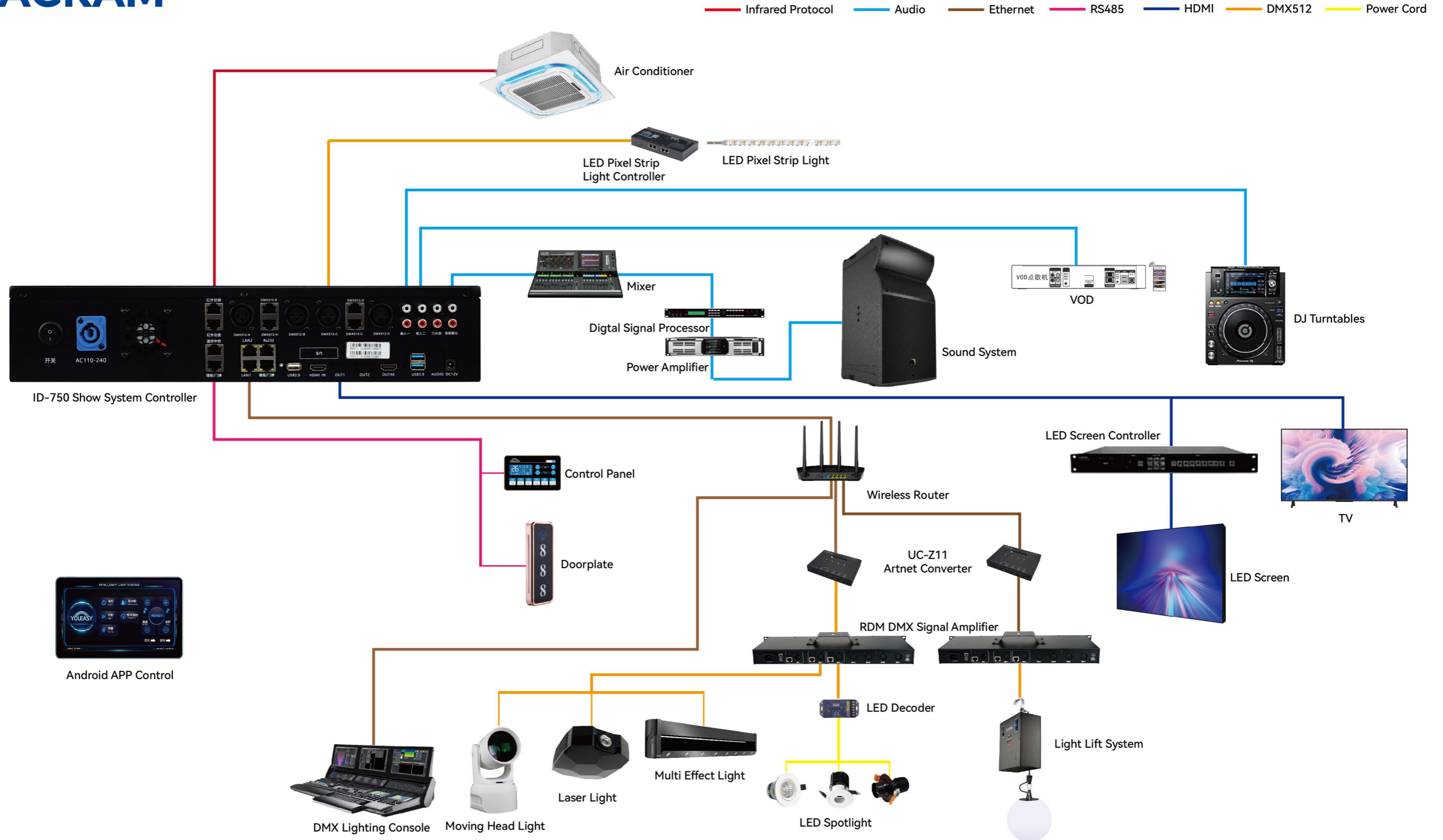



02

DMX CONTROLLER

DMX CONTROLLER

UC-X3S DMX Controller

(Support up to 8192CH output)



FEATURES

The DMX controller intelligently sets and enables one-touch switching of lighting scenes. It integrates central control functions such as Video On Demand (VOD) connectivity and amplifier control, eliminating the need for a central control box. It also features a mini control port for worry-free extension of VOD connections, supporting direct connections to devices such as LED moving head lights, laser lights, decoders, LED controllers, and LED pixel strip light controller complying with the DMX512 protocol interface.

The controller supports the recording of data from any console and make the lighting show editing easier for the designers. Through infrared signals and wall panel controls, it manages air conditioning. When connected to a computer, it allows for programming of lighting scene effects through user-friendly software, with a simple and understandable interface, facilitating installation and debugging for engineering personnel.

- Cloud Backup And Auto Matching
- Data Cloning
- Lighting Effects
- Professional Synthesis Mode
- Regular Synthesis Mode
- Lighting Show Editing
- Built-in Pixel Mapping
- Built-in Lighting Console
- Recording Lighting Data
- AI Audio Analysis
- Artnet Output
- APP Control

HARDWARE SYSTEM

Utilizing the SOC+ARM solution, running on the Linux operating system, it effortlessly achieves system networking with a built-in 100M Ethernet network.

SOFTWARE SYSTEM

The software supports external lighting consoles while also featuring an advanced built-in lighting console. It supports preset or custom lighting effect plugins, with a maximum capacity for 96 lighting programs. Users can adjust the timeline, and the new visual synthesis interface adopts an 8-layer visual operation, making debugging intuitive and convenient. It supports up to 48 lighting scenes, with each scene able to be associated with 6 visual synthesizers.

APPLICABLE SCENARIOS



PRODUCT DIMENSIONS

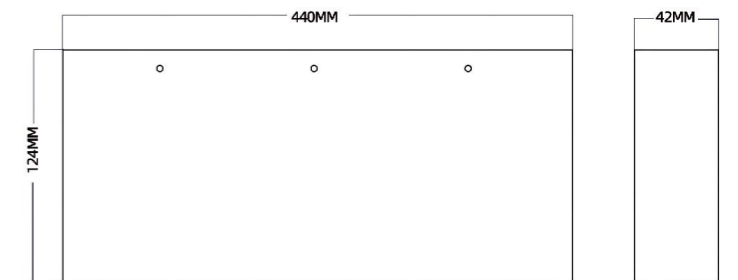

UC-X3SULTRA/X3S+/X3S

8192CH/2048CH/1024CH
DMX Controller



UC-X3SA/X3SH

1024CH/512CH
DMX Controller



UC-X3M

512CH
DMX Controller



UC-X3C

512CH
DMX Controller



Technical Parameters						
Cloud Backup And Auto Matching	√	√	√	√	√	√
Data Cloning	√	√	√	√	√	√
Lighting Effects	√	√	√	√	√	√
Built-in Pixel Mapping	√	√	√	√		
Built-in Lighting Console	√	√	√	√	√	√
Recording Lighting Data	√	√	√	√		
Professional Synthesis Mode	√	√	√	√	√	√
Regular Synthesis Mode	√	√	√	√	√	√
Lighting Show Editing	√	√	√	√		
AI Audio Analysis	√	√	√	√		
Artnet Output	√	√	√	√		
APP Control	√	√	√	√	√	
Music Play	2024 Version	2024 Version	2024 Version	2024 Version		

UC-X3SULTRA

8192CH
DMX Controller



UC-X3S+

2048CH
DMX Controller



UC-X3S

1024CH
DMX Controller



UC-X3SA/X3SH

1024CH/512CH
DMX Controller



Technical Parameters

Online Mode	Online debugging via network	Online debugging via network	Online debugging via network	Online debugging via network
Data Backup Copy	Built-in storage, network or USB disk copy and copy	Built-in storage, network or USB disk copy and copy	Built-in storage, network or USB disk copy and copy	Built-in storage, network or USB disk copy and copy
DMX512 Control Channel	8192CH-ArtNet	2048CH-ArtNet	1024CH-ArtNet	1024CH/512CH
Switching Channels & Power	No strong current channel	No strong current channel	No strong current channel	6*3KW +1KWExhaust+5CH Air conditioning
Display	LED display menu	LED display menu	LED display menu	LED display menu
Audio Switching	Supports 3 sets of audio inputs and switching	Supports 3 sets of audio inputs and switching	Supports 3 sets of audio inputs and switching	Supports 2 sets of audio inputs and switching
Central control function	Connect wall panels and door plates through LINK protocol to communicate with VOD, infrared control power amplifier and air conditioner, etc.	Connect wall panels and door plates through LINK protocol to communicate with VOD, infrared control power amplifier and air conditioner, etc.	Connect wall panels and door plates through LINK protocol to communicate with VOD, infrared control power amplifier and air conditioner, etc.	Connect wall panels and door plates through LINK protocol to communicate with VOD, infrared control power amplifier and air conditioner, etc.
Audio Player	Can upload audio in formats such as MP3, enabling audio playback synchronized with lighting, perfectly matching for lighting shows.	Can upload audio in formats such as MP3, enabling audio playback synchronized with lighting, perfectly matching for lighting shows.	Can upload audio in formats such as MP3, enabling audio playback synchronized with lighting, perfectly matching for lighting shows.	None
MQTT Server	Facilitates interaction with tablet apps, supporting app control.	Facilitates interaction with tablet apps, supporting app control.	Facilitates interaction with tablet apps, supporting app control.	Facilitates interaction with tablet apps, supporting app control.
Installation Methods	Cabinet /wall installation	Cabinet /wall installation	Cabinet /wall installation	Cabinet /wall installation
Accessories	Wall installation accessories x 2pcs	Wall installation accessories x 2pcs	Wall installation accessories x 2pcs	Mini central contro x 1pc, Plug for Air conditioning x 1
Dimensions	440*124*42	440*124*42	440*124*42	400x205x70

CONTROL HOST TOPOLOGY MAP

UC X3S+intelligent control host topology diagram

— Infrared Protocol — Audio — SPI — Ethernet — HDMI — DMX512 — Power Cord

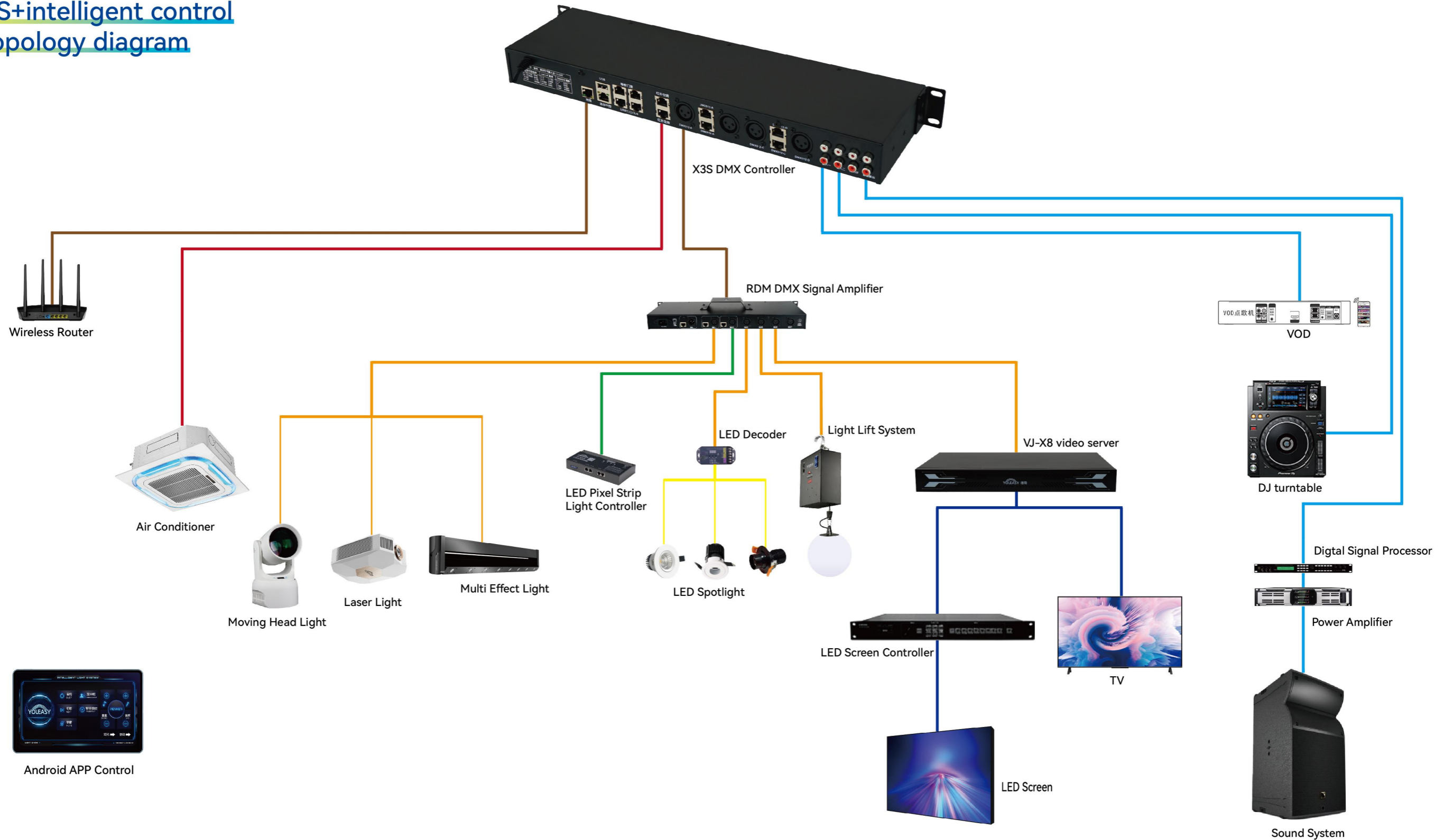



03

CONTROL SYSTEM ACCESSORIES

UC-Z08 Timing Control



TECHNICAL PARAMETER

Supports independent scene control for up to 6 time periods each day. Independent settings for days, weeks, months, years, and commonly used holidays.

Supports 16 scenes.

Size: 143*56*24mm

* Programming based on holidays is available, with the ability to store programs. Pre-programmed routines can be used during the specified time periods.

RD-106 DMX Signal Amplifier



TECHNICAL PARAMETER

DMX512 signal amplification and distribution (1 of input and 6 output), supports RDM and remote DMX address setting

Features: Input and 2 of output is for RJ45, others for XLR; Independent power isolation, signal amplification and nanosecond-level RDM response speed.

Size: 440*124*42mm

UC-ZW1 Wireless Transceiver



TECHNICAL PARAMETER

Functions: Wireless bidirectional transmission of DMX512 signals; when used in pairs, it can replace wired transmission, suitable for situations where it is inconvenient to install wired control circuits.

Features: 2.4G wireless transmission, strong anti-interference capability, supports one-to-many.

Main Interfaces: DMX512

Control Ports: RJ45 * 2, XLR Male * 1, XLR Female * 1

Size: 125*140*40mm

RD-105 DMX Signal Amplifier



TECHNICAL PARAMETER

DMX512 signal amplification and distribution (1 of RJ45 input, 5 of RJ45 output), with electrical isolation for input and output.

Supports: RDM compatible devices.

Features: Compact size, independent amplification for each output

Accessories: DC12V 1A adapter

Size: 143*56*24mm

UC-Z11 Artnet-DMX Converter



TECHNICAL PARAMETER

With LCD display

Supports bidirectional ARTNET conversion of 4*512 = 2048 channels.

Features: Manual setting IP, independent 4 groups of 512 opto-isolations.

Main Interface: DMX512.

Accessories: DC12V 1A Adapter.

Size: 156*110*28mm

CONTROL PANEL

185 Series



▲ Customizable Interface

Series

PRODUCT DESCRIPTION

Suitable for KTV, bars and clubs to centralized control of lighting, air conditioning, exhaust, etc. It features a capacitive touch glass panel for sensitive and excellent touch control.

It features a capacitive touch glass panel for sensitive and excellent touch control. The main structure is made of die-cast zinc alloy, with a polished and electroplated surface for a robust and elegant appearance, very easy to install.

PRODUCT DIMENSIONS

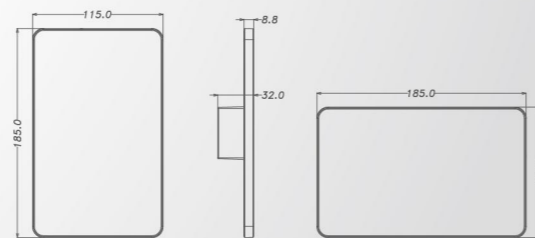

CUSTOMIZABLE INTERFACE



UC-301

Wall Panel with 12 keys (Horizontal type)



UC-303

Wall Panel with 12 keys (Horizontal type)



UC-309

Vertical type with LED indicator, Wall Panel with 16 keys



UC-310

Horizontal type with LED indicator Wall Panel with 9 keys



UC-303D

Wall Panel with 18 keys (Horizontal type)



Technical Parameter Comparison Table

Customizable Colors	Supports gradient colors, no color limitation			3D stereo keys, no color limitation	
Maximum Keys	12pcs	18pcs	16pcs	9pcs	18pcs
Keys Indicator	/	/	4 lighting modes indicator	Air conditioning/exhaust indicator	/
Frame Material	Aluminum alloy/high gloss ABS				
Frame Color	Rose gold, titanium black, silver			Rose gold, titanium black	
Interface	RS485, Dual RJ45				
Touch Screen	Tempered glass, capacitive touch				
Installation Method	Sliding buckle			Sliding buckle	Sliding buckle
Dimension	185(H)*115(W)*8.8 (D)mm/115(H)*185(W)*8.8 (D)mm				

▲ Customizable Interface

INTELLIGENT CONTROL WALL PANEL SERIES INSTALLATION METHOD

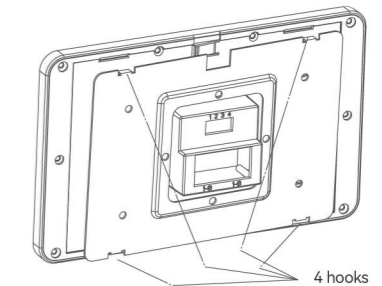
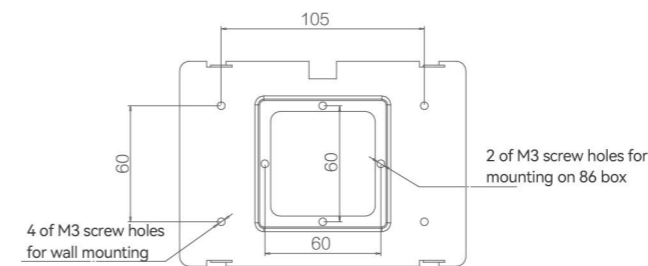

Fix the sheet metal parts on the 86 bottom box or on the wall.

Insert the control panel into the 4 hooks on the sheet metal part and slide it to the left to lock.

CONTROL PANEL

185 With LCD Series



▲ Customizable Interface

With LCD Series

PRODUCT DESCRIPTION

Suitable for KTV, bars and clubs to centralized control of lighting, air conditioning, exhaust, etc. It features a capacitive touch glass panel for sensitive and excellent touch control.

It features a capacitive touch glass panel for sensitive and excellent touch control. With LCD display, it's more convenient to set the temperature and modes on the air conditioning control. The main structure is made of die-cast zinc alloy, with a polished and electroplated surface for a robust and elegant appearance, very easy to install.

CUSTOMIZABLE INTERFACE



PRODUCT DIMENSIONS

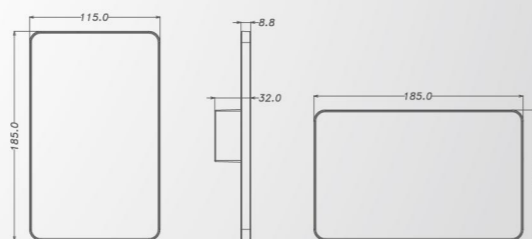

UC-302A

Vertical type with LCD display
Wall Panel with 16 keys



UC-302A

Vertical type with LCD display
Wall Panel with 16 keys



UC-302D

Vertical type with LCD display
Wall Panel with 15 keys



UC-308

Horizontal type with LCD display
Wall Panel with 16 keys



Technical Parameter Comparison Table

Customizable Colors	Supports gradient colors, no color limitation	White/Gold/Other	3D stereo keys, no color limitation	Supports gradient colors, no color limitation
Maximum Keys	16pcs	16pcs	15pcs	16pcs
Keys Indicator	6 of independent backlight indicators, 10 of integrated backlights	/	/	Independent backlight indicator
Service Call Indicator	/	/	Independent backlight dual-color flashing indication	/
LCD Display	Air conditioning/exhaust indicator			
Temperature Detection	Temperature sensor			
Frame Material	Aluminum alloy/high gloss ABS			
Frame Color	Rose gold, titanium black, silver	Rose gold, titanium black	Rose gold, titanium black	Rose gold, titanium black
Interface	RS485, Dual RJ45			
Touch Screen	Tempered glass, capacitive touch			
Installation Method	Sliding buckle			
Dimension	185(H)*115(W)*8.8 (D)mm/115(H)*185(W)*8.8 (D)mm			

INSTALLATION METHOD

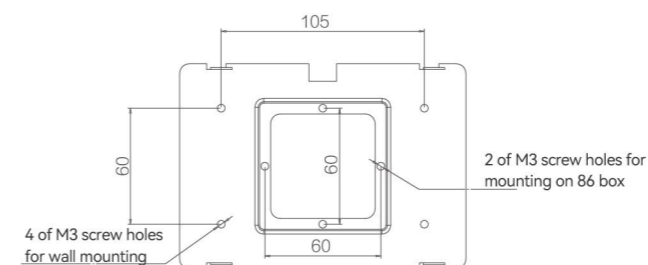

Fix the sheet metal parts on the 86 bottom box or on the wall.

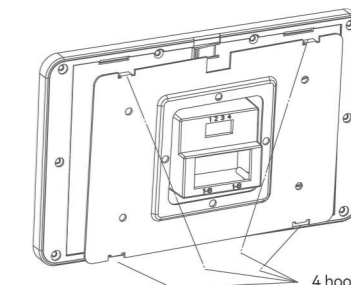

Insert the control panel into the 4 hooks on the sheet metal part and slide it to the left to lock.

CONTROL PANEL

UC-A05 6 Keys



TECHNICAL PARAMETER

Colors: Customizable
Keys: 6
Key Indication: Independent backlight indication
Frame Material: High-gloss ABS
Frame Color: Gold
Interface: RS485, dual RJ45
Touch Screen: Tempered glass, capacitive touch
Installation Method: Sliding buckle
Size: 95*95*8.8mm

▲ Customizable Interface

PRODUCT DIMENSIONS

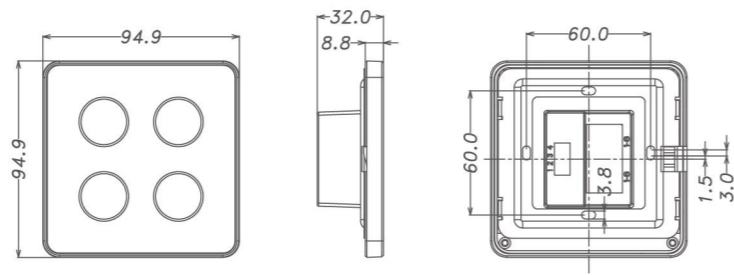

CUSTOMIZABLE INTERFACE



CONTROL PANEL

UC-A01 Service Panel



TECHNICAL PARAMETER

Colors: Customizable
Keys: 1
Key Indication: Independent backlight indication
Frame Material: High-gloss ABS
Frame Color: Gold
Interface: RS485, dual RJ45
Touch Screen: Tempered glass, capacitive touch
Installation Method: Sliding buckle
Size: 95*95*8.8mm

▲ Customizable Interface

PRODUCT SIZE

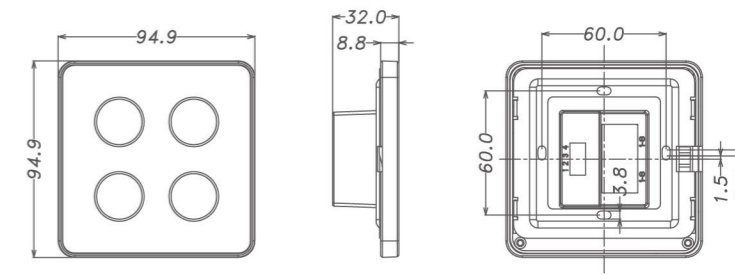

CUSTOMIZABLE INTERFACE



CONTACT US

DONGGUAN YOUEASY ELECTRONIC TECHNOLOGY CO., LTD

8-9 / F, Changrong High-tech Park, Huaide Yayao Industrial Zone,
Humen Town, Dongguan City

Official website: www.szyoueasy.com The hotline is +86 189-3816-0702

South China Sales Branch: 8th Floor, Changrong High-tech Park, Huaide Yayao Industrial Zone, Humen Town, Dongguan City, Guangdong Province

Western Sales Branch: 403, Building 6, Zhaoxin Center, 86 Wuxing Road, Wuhou District, Chengdu City, Sichuan Province

North Sales Branch: Room 1207, Hongyuehua Business Building (Kejin Building), No. 27, Qilibao Road, Hongjialou Street, Licheng District, Jinan City

East China Sales Branch: Room 322, 3rd Floor, Block C, No. 45, Xiangyuan Road, Gongshu District, Hangzhou (Panshi Global Digital Economy Industrial Park)

Foshan Manufacturing Base: Room 501, 5/F, Building 4, No. 38, Lishui East Industrial Park, Shengli Community, Lishui Town, Nanhai District, Foshan, China



Scan code and Contact us